

LIGHTNING PROTECTION INTERNATIONAL PTY LTD

**LPI**<sup>®</sup>

# STORMMASTER ESE Air Terminal





## The LPI story

Lightning Protection International Pty Ltd (LPI) is a fully Australian owned manufacturer and supplier of direct strike lightning protection, transient voltage surge suppression, and earthing / grounding solutions.

For many years, LPI have been providing specialist lightning protection advice to customers in some of the most lightning prone areas of the world. Our personnel have extensive experience in risk management, system design, training, installation, certification, and commissioning of systems in a wide variety of industry groups.

LPI maintains a third party Quality Management System to AS/NZS ISO 9001:2008.

LPI's range of products and services are exported from its head office and research facility (in Tasmania, Australia) and via regional offices worldwide.

The company has been recognised within Australia for its outstanding export successes and has been awarded several prestigious export awards.

## LPI's 4-Step Approach to Lightning Protection Active in Industry

It is the strategic aim of our company to be able to provide a complete packaged solution. LPI has identified 4 key steps when considering the complete approach to lightning protection, ask for our LPI 4 Step approach to lightning protection.

### Our system design approach includes:

- 1 Definition and provision of area protection
- 2 Creation of a bonded earthing system
- 3 Protection of mains power lines
- 4 Protection of signal, data and communication lines





# LPI STORMASTER ESE AIR TERMINAL

## LPI's Stormaster ESE

The LPI Stormaster (Early Streamer Emission) range of terminals provides a safe and efficient system for the protection of your facility from direct lightning strikes. The LPI Stormaster ESE terminal captures the lightning energy at a **preferred point**.

## How does the LPI Stormaster ESE Terminal work?

The Stormaster ESE air terminal uses the naturally occurring electrical field to complete the timely release of an upward streamer. This process provides for a safe and efficient method of controlling dangerous lightning energy at a preferred point.

As a thunderstorm gathers overhead, the ambient electrical field surrounding the Stormaster ESE begins to rise in voltage. Upon the approach of a downward leader towards the protected area, there is a rapid increase in the electric field which initiates the triggering of an upward streamer from the Stormaster ESE terminal. The early initiation allows for a larger or enhanced area of protection to be provided by the Stormaster ESE in comparison to a conventional rod, in accordance with NF C 17-102 (2011).



With the release of the upward streamer from the finial tip earlier than other competing structural points, the Stormaster ESE terminal becomes a preferred point for the capture of the lightning discharge within the protected area.

## The Stormaster ESE range

LPI Early Streamer Emission (ESE) air terminals in both **Anodised Aluminium** and **Stainless Steel**.

**Ordering Code:**

STORMASTER ESE-XX-YY-ZZ

**XX:** Available in **15, 30, 50** and **60**

**YY:** Blank for Gold (anodised aluminium) model, **SS** for stainless steel model

**ZZ:** Blank for standard model (to FRP Mast), **GI** for 2 inch BSP GI pipe adaptor

**Stormaster ESE Tester:**

Ordering Code: Stormaster-ESE-Tester

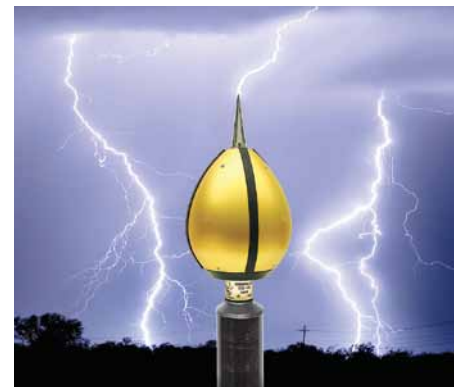

## Certified Performance

As one of the leading companies in the field of lightning protection, LPI has invested heavily in field and laboratory testing as part of its on-going commitment to research and development.

Throughout the product development of the Stormaster ESE, the proto-type models were subjected to intense testing under high voltage conditions. Following further refinements, the Stormaster terminals were subjected to final testing by an independently accredited test laboratory which completed testing in full compliance with the **French National Standard**



**NF C 17-102 (2011)**. The final testing of Stormaster ESE terminals showed effective performance as defined in this Standard.

All Stormaster terminals tested by the ITE HV laboratory in Europe, which has national (ENAC) and international (ILAC / ISO IEC) accreditation.

# LPI STORMASTER ESE AIR TERMINAL

## Downconductors

NF C 17-102 [2011] requires the installation of two downconductors for each installed ESE air terminal, with one downconductor permitted to use electrically continuous natural components of the structure.

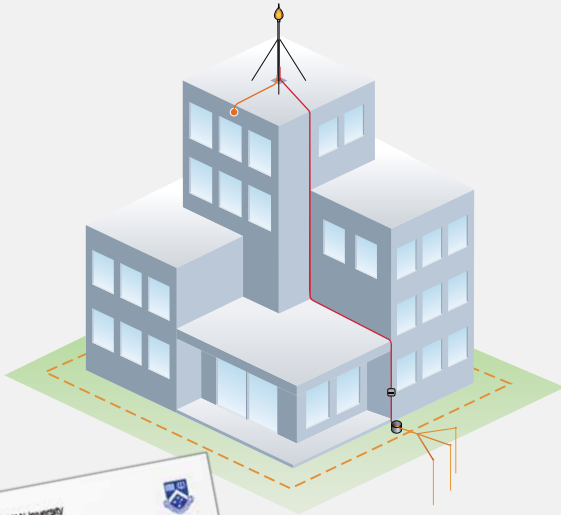

HVSC Plus has been tested by a certified, independent high voltage laboratory located at Monash University, Australia. Withstand Voltage  $\geq 500\text{KV}$

LPI offers a selection of downconductors and fixing accessories:

### High Voltage Shielded Cable (HVSC Plus)

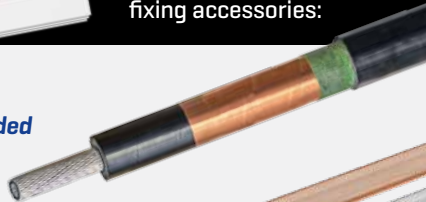

### Flat tapes - Bare, Tinned & PVC Covered



### PVC Coated and bare stranded copper cable

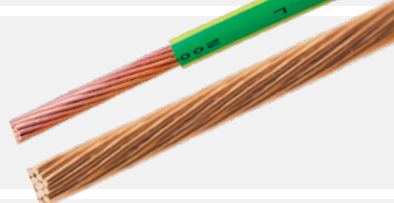

### Downconductor Fixings and Connectors



## Lightning Strike Recorder (LSR)

LPI have developed a LSR which is designed for easy mounting on a downconductor to effectively count the number of lightning strikes captured by the Stormaster ESE Terminal. LSR Tester available on request, contact LPI for details.



## Lightning Protection Earths

The installation of a radial earthing arrangement with end caps is recommended for each lightning protection earth. The radial earthing configuration provides an effective means for the safe dissipation of the lightning energy into the ground mass. All individual lightning earths should be bonded together in a ring earth arrangement to minimise ground loops and potential differences under transient conditions. Compliance to NF C 17-102 [2011] requires an earth resistance reading of less than 10 Ohms for the lightning earths.

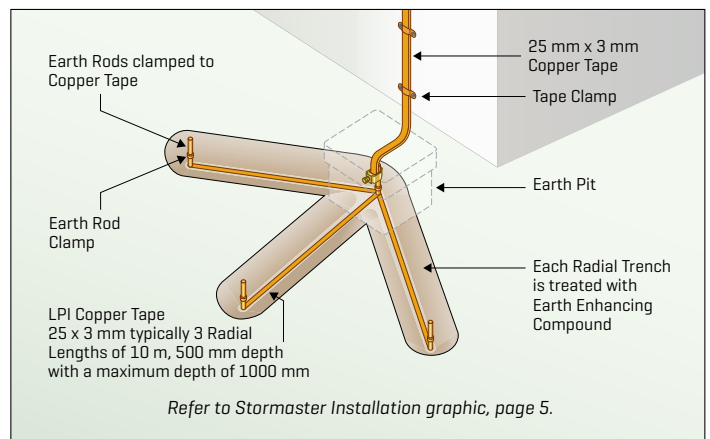

Key components of a lightning earth include:

- Earth Rods** - Copperbonded (threaded or unthreaded), Solid Copper or Stainless Steel
- Earth Enhancing Compounds** to assist in lowering soil resistance
- Mechanical Clamps and Earth Pits** Polymer earth pit
- Earthing Conductor** - Use of flat copper tape is recommended as it provides greater surface contact with the soil mass as opposed to circular or stranded copper conductors



# LPI STORMASTER ESE AIR TERMINAL

## Protection Performance

The protection radius [ $R_p$ ] of a Stormaster ESE terminal is calculated using the following formula as defined in NF C 17-102 (September 2011), namely:

$$R_p(h) = \sqrt{2rh - h^2 + \Delta[2r + \Delta]} \text{ for } h \geq 5 \text{ m}$$

and

$$R_p = h \times R_{p5} / 5 \text{ for } 2 \leq h < 5 \text{ m}$$

where  $h$  = Stormaster height relative to the area being protected (m)

$R_{p5}$  = value of  $R_p$  from Eqn. [1] when  $h = 5$  m

$r$  = 20 m for protection level I (Very High protection)  
 30 m for protection level II (High protection)  
 45 m for protection level III (Medium protection)  
 60 m for protection level IV (Standard protection)

and  $\Delta$  = Stormaster time and height advantage according to the Stormaster model installed:

- Choices:
- Stormaster ESE 15:  $\Delta = 15 \mu\text{s}$
  - Stormaster ESE 30:  $\Delta = 30 \mu\text{s}$
  - Stormaster ESE 50:  $\Delta = 50 \mu\text{s}$
  - Stormaster ESE 60:  $\Delta = 60 \mu\text{s}$

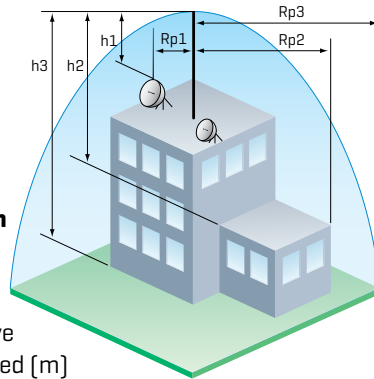

## Stormaster Installation

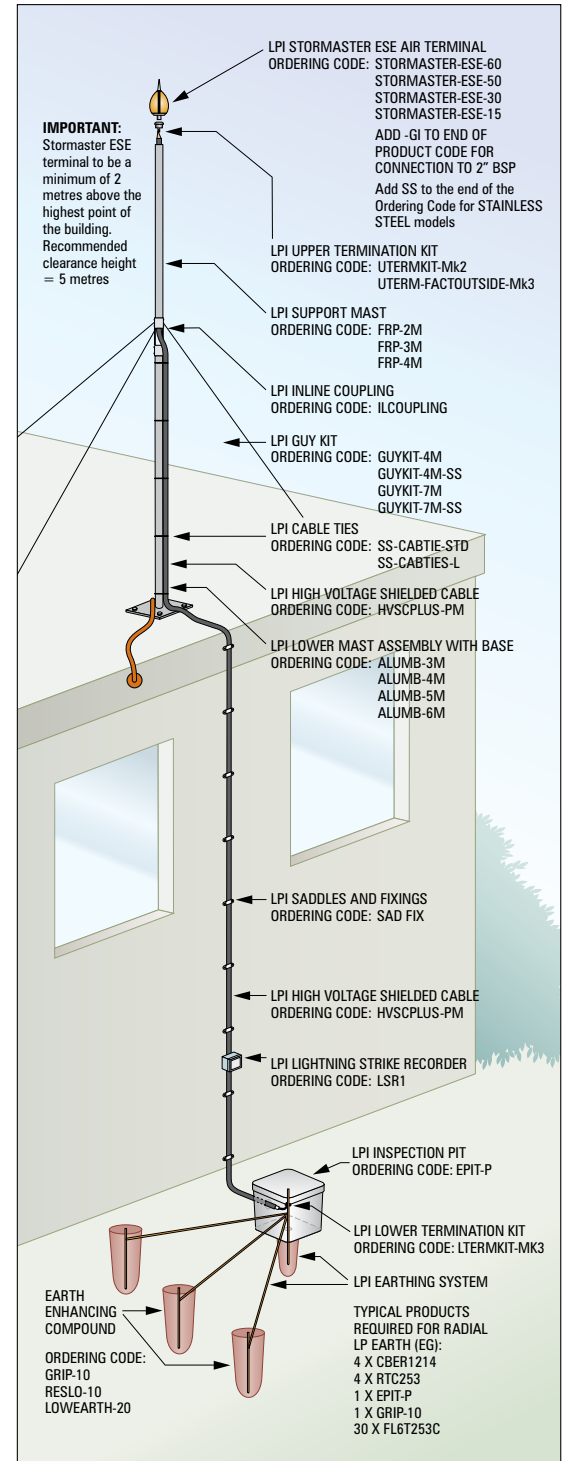

PROTECTION RADIUS, $R_p$ (m)											
$h$ = height of Stormaster ESE terminal above the area to be protected (m)	2	4	5	6	10	15	20	45	60	80	100
<b>Protection Level I (Very High)</b>											
Stormaster ESE 15	13	25	32	32	34	35	35	35	35	35	35
Stormaster ESE 30	19	38	48	48	49	50	50	50	50	50	50
Stormaster ESE 50	27	55	68	69	69	70	70	70	70	70	70
Stormaster ESE 60	31	63	79	79	79	80	80	80	80	80	80
<b>Protection Level II (High)</b>											
Stormaster ESE 15	15	30	37	38	40	42	44	44	44	44	44
Stormaster ESE 30	22	44	55	55	57	58	59	59	59	59	59
Stormaster ESE 50	30	61	76	76	77	79	79	79	79	79	79
Stormaster ESE 60	35	69	86	87	88	89	89	89	89	89	89
<b>Protection Level III (Medium)</b>											
Stormaster ESE 15	18	36	45	46	49	52	55	60	60	60	60
Stormaster ESE 30	25	51	63	64	66	69	71	75	75	75	75
Stormaster ESE 50	35	69	86	87	88	90	92	95	95	95	95
Stormaster ESE 60	39	78	97	97	99	101	102	105	105	105	105
<b>Protection Level IV (Standard)</b>											
Stormaster ESE 15	20	41	51	52	56	60	63	73	75	75	75
Stormaster ESE 30	29	57	71	72	75	78	81	89	90	90	90
Stormaster ESE 50	38	76	95	96	98	100	102	109	110	110	110
Stormaster ESE 60	43	85	107	107	109	111	113	119	120	120	120

Contact LPI for Protection Radius for Level I+ and Level I++

### Disclaimer

- LPI maintains a policy of on-going product development, specifications are subject to change without notice.
- Application detail, illustrations and schematic drawings are representative only and should be used as guides.
- It should be noted that 100% protection for direct strike lightning, lightning detection and surge and transient protection equipment is not possible and cannot be provided due to the lightning discharge process being a natural atmospheric event.



# LPI STORMASTER ESE AIR TERMINAL

## Advantages of the Stormaster ESE Terminal

A typical Stormaster ESE installation consists of a single Stormaster ESE terminal with an enhanced area of protection and downconductors connected to a dedicated earthing system designed to have a low impedance to lightning.

- LPI's Stormaster ESE system is simple to install and requires no special maintenance.
- LPI's Stormaster ESE system is a cost-effective lightning protection solution whilst providing superior safety.
- The Stormaster ESE range of terminals have been fully tested in accordance with NF C 17-102 (2011) in a high voltage laboratory, under high current impulses and environmental chambers.

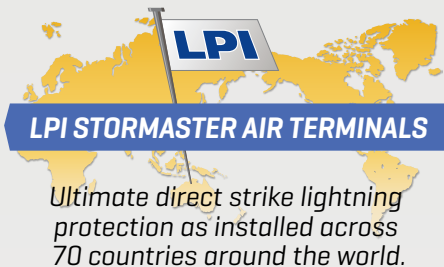

## NF C 17-102 (2011) The New Standard

NF C 17-102 is written specifically to ensure compliance with regard to the testing, application and installation of ESE terminals. The new standard, issued in 2011, is deemed to be applicable to structures of any height and for the protection of open areas. The previous version of the standard, first published in 1995, has been cancelled by the French standards organisation UTE and conformity with that version ceased in September 2012.

NF C 17-102 (2011) includes much more stringent requirements when compared to the 1995 version. The main differences are as follows:

1. There are now four protection levels rather than the previous three levels.
2. There are two new enhanced sub-levels for protection level I (levels I+ and I++).
3. Protection of structures taller than 60 metres is now allowed and there are special rules with regard to strike interception and downconductors. The top 20% of tall buildings needs to be protected.
4. Some simple rules regarding downconductors, commonly two, are needed, but one of them can be the natural components of the structure.

5. The earlier ban on coaxial insulated downconductors has been removed, but any use of insulated conductors has to follow the separation distance requirements per the IEC 62305 standards.



## Research and Development

LPI has an ongoing commitment to Research and Development.

LPI personnel and its associates have been involved in a number of field trials in the most lightning prone regions of the world. This experience has extended throughout such countries as Australia, Indonesia, Sri Lanka the USA and South Korea.



Testing of the Stormaster Terminal: ITE HV Laboratory, Europe

Distributed by:

**LIGHTNING PROTECTION  
INTERNATIONAL PTY LTD**

ABN 11 099 190 897

**LPI**<sup>®</sup>

PO Box 379 Kingston, Tasmania, Australia 7051  
49 Patriarch Drive, Huntingfield, Tasmania, Australia 7055

- Telephone: *Australia:* 03 6281 2477  
*International:* +61 3 6281 2480
- Facsimile: +61 3 6229 1900
- Email: [info@lpi.com.au](mailto:info@lpi.com.au)
- Web: [www.lpi.com.au](http://www.lpi.com.au)